

## Specification of: RDA 21-2225-2E

### Centrifugal Roof Fan Nicotra Gebhardt genovent

with swirl free horizontal directed discharge for gas medium up to app. +40 °C. Stylish casing and base frame with intake nozzle made of galvanised steel sheet Flange connection at intake acc. to DIN 24155-2 Discharge outlets protected from the weather with an aerodynamically shaped grille. Centrifugal impeller with backward curved blades, mounted on the rotor of a variable speed integral external rotor motor, protected to IP 44. Motor protection is through direct switching thermal contacts in the motor winding, Dynamically balanced, installed vibration free, totally maintenance free. Performance data in according DIN 24166 tolerance class 2 (BS 848 Class "B"). Meets the efficiency requirements of Regulation EU1253/2014 for ventilation units. Within europe only operation with electronic speed controller allowed.

### Technical data of the fan: RDA 21-2225-2E

[fulfills the ErP requirements 2018 at BEP](#)

Description	Value Dimension
<b>Specified duty point</b>	
<b>Actual duty point</b>	
Installation acc. DIN 24163 Part 1	A
Reference density (Rho1)	1.20 kg/m <sup>3</sup>
Medium temperature (t)	20 C
Fan weight	8 kg
<b>Rated data</b>	
Phases-Voltage-Frequency	1~230-50 V-Hz
Number of poles:	2
Rated motor speed (n <sub>N</sub> )	2740 min <sup>-1</sup>
Rated motor current (I <sub>N</sub> )	1,1 A
Capacitor (C)	5,0 µF
<b>operational limits</b>	
Max. absorbed power (P <sub>tmax</sub> )	0.25 kW
Max. fan speed (n <sub>vmax</sub> )	3000 min <sup>-1</sup>
Max. operating frequency (f <sub>max</sub> )	50 Hz
Temperature range of conveying medium (t <sub>min</sub> ...t <sub>max</sub> )	-20...60 C

## Fan curve to RDA 21-2225-2E

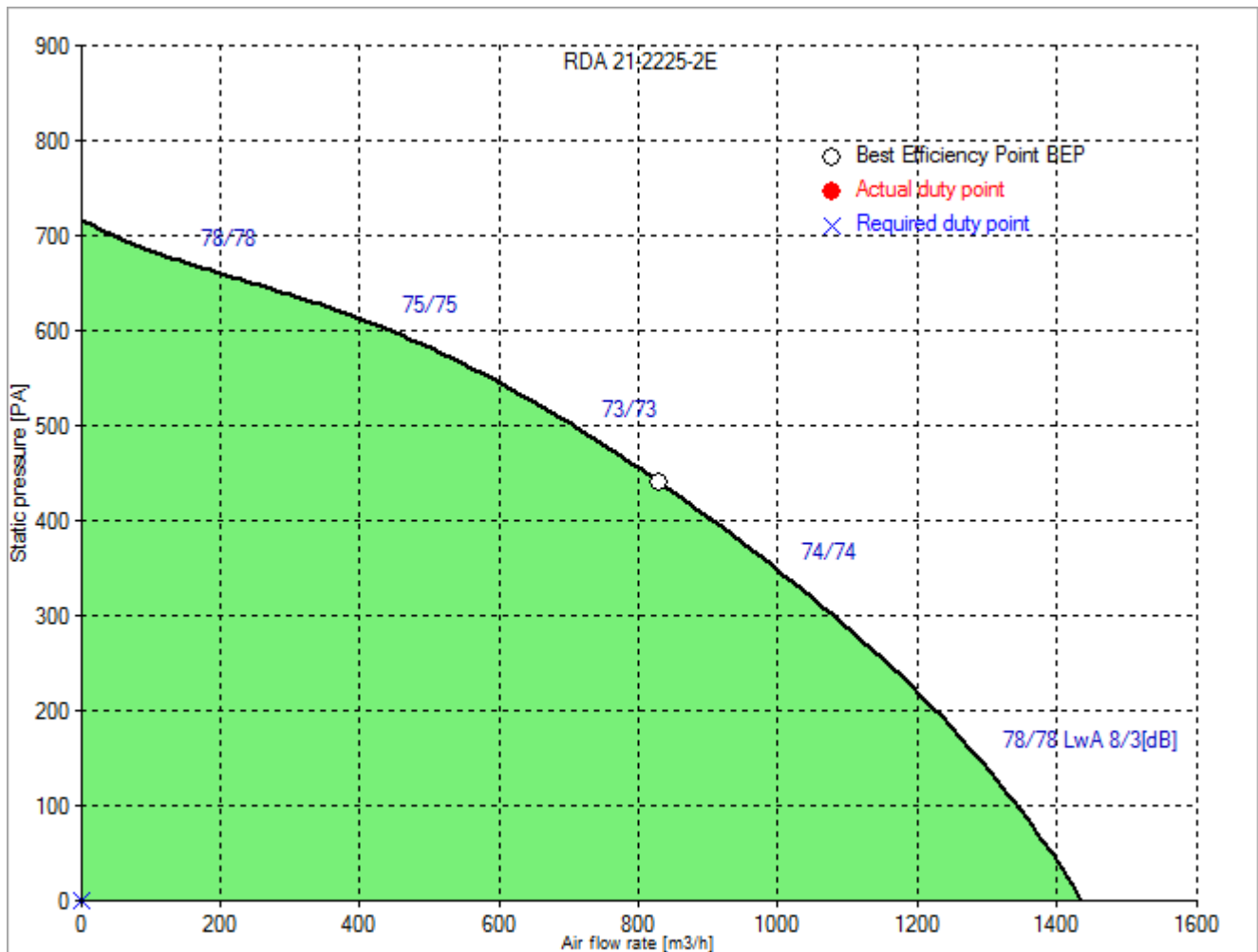

## Dimensions to RDA 21-2225-2E

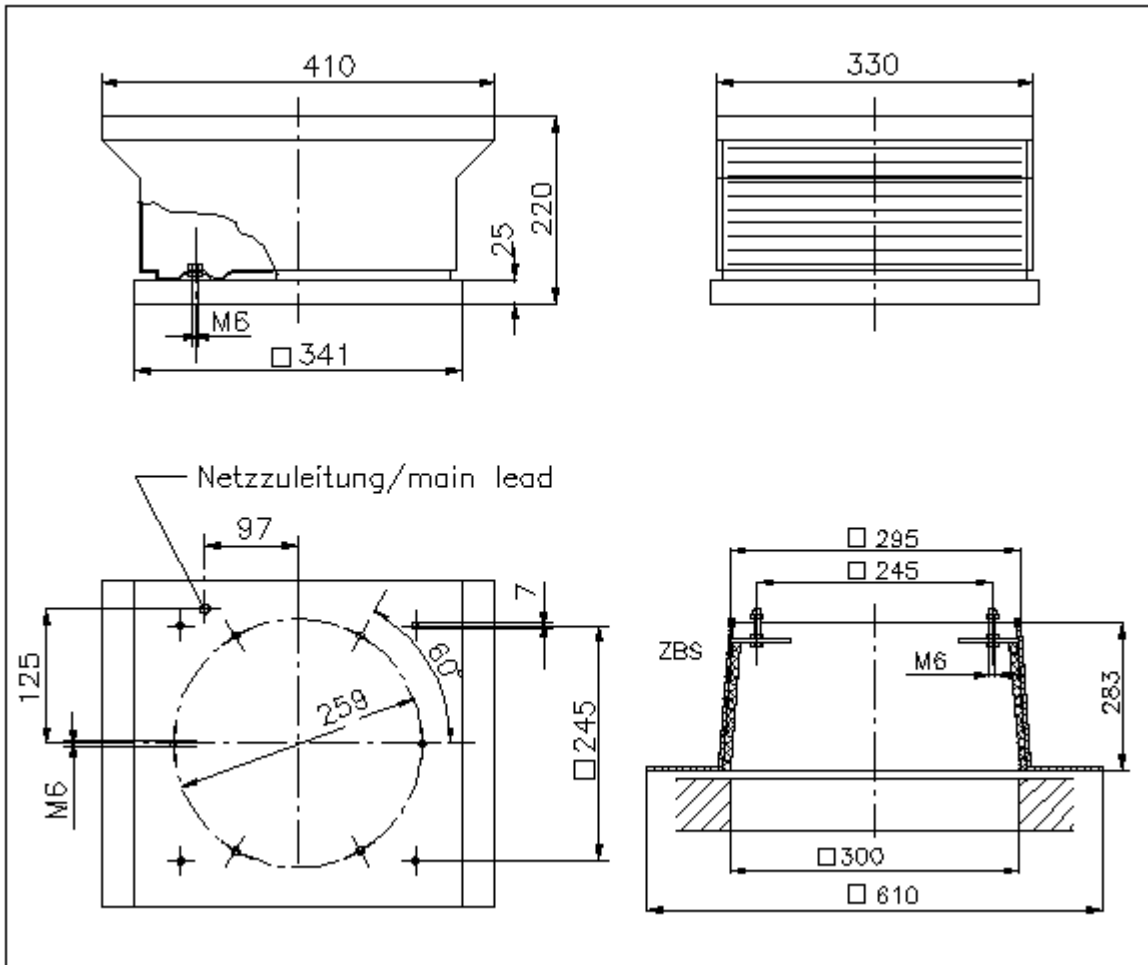

Rotation:  
Handing:

RD  
90